

TD/PM Circle-H lighting system

Explosion proof LED touchdown/positioning and heliport identification marking light system

Getting your crew safely to and from offshore locations can be challenging. To improve the safety of (night) helicopter manoeuvres offshore, Orga designed an explosion proof LED touchdown/positioning and heliport identification marking light system in conjunction with and approved by the UK CAA (CAP437). The robust and reliable LED lighting system eliminates the dangerous and disorienting 'black-hole' effect and provides pilots with the best possible visual cues during approach and landing of the helicopter in all weather conditions. The lights in Orga's TD/PM Circle-H lighting system burn steady yellow and green. The yellow lights illuminate the Touchdown/Positioning Marking Circle, while the green lights illuminate the Heliport Identification Marking 'H'. The lighting system supports smoother and more controlled landing, which reduces helicopter landing risks and makes sure your helideck safety complies.

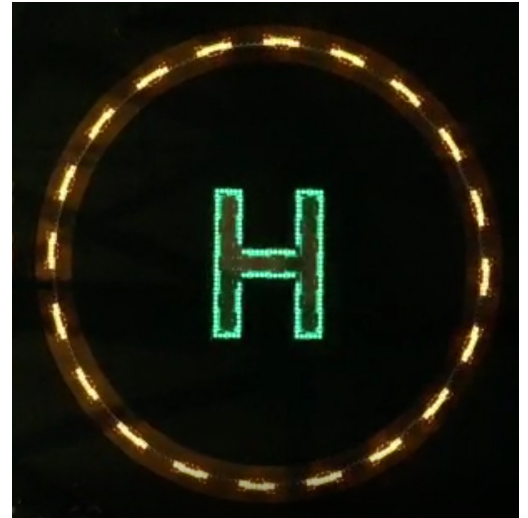

KEY FEATURES

- No black hole effect
- High quality marine materials
- Strong flexible metal parts with low profile for a range of wheel and skid landing gear
- Modular lighting system
- Minimal installation time
- Robust cable protection
- Compatible to be used in combination with DIFF system
- State of the art high power LED and technology provides superior life and reliability
- Low system power consumption
- Proven to meet the operational and environmental requirements offshore
- Suitable for high pressure jet cleaning

STANDARDS/CERTIFICATION

- CAAi and HCA system approval to CAA-UK CAP 437; 9th edition appendix C
- ABS Certificate of Design Assessment – Orga CAP437 TD/PM Circle-H System – 15-LD1264711-PDA
- IECEx, ATEX and Inmetro (optional) certificate for all relevant components available

PERFORMANCE CHARACTERISTICS

- Steady burning; green H lighting and yellow Circle lighting
- Effective intensity H: 2-12° max. 60 cd; 12-20° max. 30 cd and 20-90° max. 10 cd
- Effective intensity Circle: 0-10° max. 60 cd; 10-20° max. 45 cd and 20-90° max. 15 cd
- Horizontal beam coverage: as per CAP437
- Colour chromaticity: as per CAP437

TD/PM Circle-H lighting system

Explosion proof LED touchdown/positioning and heliport identification marking light system

ELECTRICAL CHARACTERISTICS

- Operating Dvoltage: from control panel (low voltage max 20Vdc)
- Power consumption: max 86 W average
- Connection details junction box: max. 10 mm²; 4xM32 entry, 1x M25 entry

PHYSICAL CHARACTERISTICS

- The Circle consisting of 'n' HTP100EX-A plates ('n' depends on D-value of the helideck – see below table) with a weight of 10 kg per plate
- The 'H' consists of 7 HTP100EX-G plates with a total weight of 240 kg
- Degree of protection: IP66, IP67 and IP69 for Circle and H
- Degree of protection: IP66 for system junction box
- Operating temperature range: -25°C to +55°C

SYSTEM DESIGN, CONTROL AND MONITORING

- Standard delivery as an 'on deck' power supply system design (see drawing below)
- The system can be provided with a 'through deck' design as an option. Please contact us to determine if this is possible on your helideck.
- Provided with cabling
- Fault monitoring with fail indication via separate system control and monitoring box (DBO-432-AC-HTP100EX – see separate datasheet)

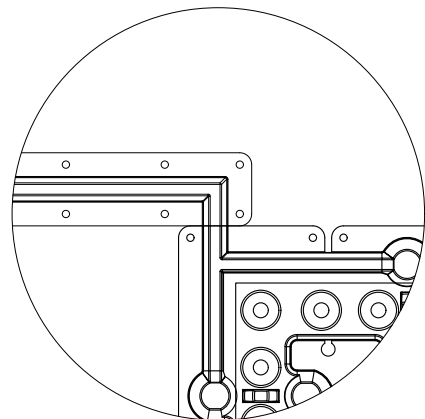
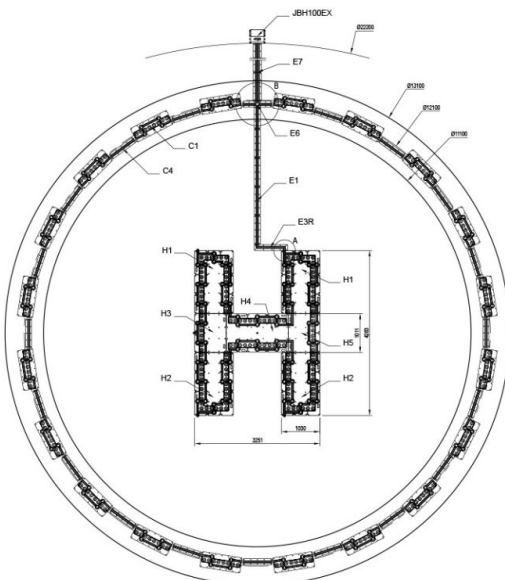

DETAIL: A

TD/PM Circle-H lighting system

Explosion proof LED touchdown/positioning and heliport identification marking light system

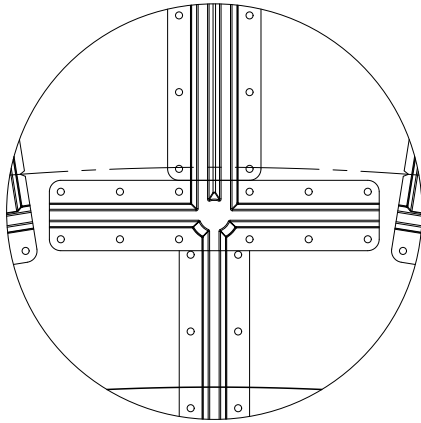

DETAIL: B

Helideck D-value		No. of Plates
Min. D-value (m)	Max. D-value (m)	HTP100EX-G (C1 Plate)
	≤14.14	16
14.23	18.76	16 – 18
18.76	19.97	18
19.97	21.18	19
21.18	22.39	20
22.39	23.60	21
23.60	24.81	22
24.81	26.02	23
26.02	27.23	24
27.23	28.44	25
28.44	29.65	26
≥30		To be advised

* Above table shows the estimate number of HTP100EXs required per D-value, please contact us for the exact outlook of the Circle-H Lighting system on your helideck.